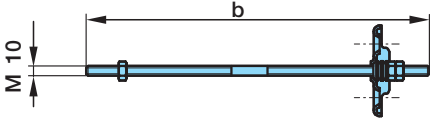
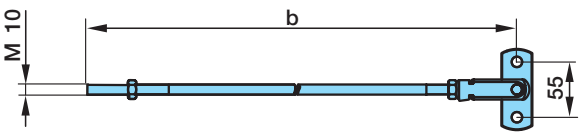
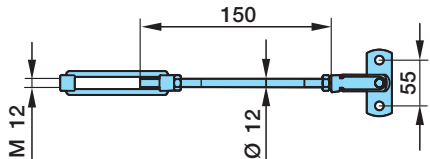

4.1 Jarrutangot yksittäisakseleita varten Linkage rods for single axles Timonerie de frein pour essieu simple Tiranteria freno per monoasse

Jarrutangot yksittäisakseleita varten M 10 Linkage rods for single axles M 10 Timonerie de frein pour essieu simple M 10 Tiranteria freno per monoasse M 10			
Jarrutankoasennelma, täydellinen – sis. vetotanko, tasapainotusvipu, 6-kulmamutteri (3x), rengas (3x) Pull rod assembly, complete – incl. pull rod, equalizer lever, hexagon nut (3x), ring (3x) Kit barre de traction cpl. – incl. barre de traction, levier compensateur, ecrou à tête hexagonale (3x), anneau (3x) Kit barra di trazione completo – incl. barra di trazione, leva compensatrice, dado esagonale (3x), anello (3x)	Pituus b Length b Longueur b Lunghezza b	Vetotanko Pull rod Barre de traction Barra di trazione	
	05.439.33.03.0	400 mm	03.399.25.48.0
	05.439.33.05.0	600 mm	03.399.25.49.0
	05.439.33.07.0	800 mm	03.399.25.40.0
	05.439.33.09.0	1000 mm	03.399.09.04.0
	05.439.08.82.0	1400 mm	03.399.08.82.0
	05.439.33.15.0	1600 mm	03.399.08.83.0
	05.439.19.03.0	1700 mm	03.399.08.89.0
	05.439.33.17.0	1800 mm	03.399.25.03.0
	05.439.33.19.0	2000 mm	03.399.25.04.0
	05.439.33.25.0	2500 mm	03.399.09.06.0
	05.439.33.30.0	3000 mm	03.399.09.01.0

Jarrutangot yksittäisakseleita varten M 10 Linkage rods for single axles M 10 Timonerie de frein pour essieu simple M 10 Tiranteria freno per monoasse M 10			
Jarrutankoasennelma, täydellinen – sis. vetotanko, tasapainotusvipu, 6-kulmamutteri (2x), vaijeriliitin Pull rod assembly, complete – incl. pull rod, brake compensator, hexagon nut (2x), yoke Kit barre de traction cpl. – incl. barre de traction, palonnier, ecrou à tête hexagonale (2x), chape Kit barra di trazione completo – incl. barra di trazione, bilanciere, dado esagonale (2x), testa di forcella	Pituus b Length b Longueur b Lunghezza b	Vetotanko Pull rod Barre de traction Barra di trazione	
	05.439.33.62.0	675 mm	03.399.02.02.0
	05.439.33.63.0	1275 mm	03.399.02.59.0
	05.439.33.64.0	1575 mm	03.399.02.86.0

Jarrutangot yksittäisakseleita varten M 12 Linkage rods for single axles M 12 Timonerie de frein pour essieu simple M 12 Tiranteria freno per monoasse M 12			
Jarrutankoasennelma, täydellinen – sis. vetotanko, tasapainotusvipu, 6-kulmamutteri (2x), vaijeriliitin, lukitusmutteri Pull rod assembly, complete – incl. pull rod, brake compensator, hexagon nut (2x), yoke, tube buckle Kit barre de traction cpl. – incl. barre de traction, palonnier, ecrou à tête hexagonale (2x), chape, ecrou de tension Kit barra di trazione completo – incl. barra di trazione, bilanciere, dado esagonale (2x), testa di forcella, dado con chiusura	Pituus b Length b Longueur b Lunghezza b	Vetotanko Pull rod Barre de traction Barra di trazione	
	05.439.32.77.0	03.399.05.90.0	

4.1 Jarrutangot pariakseleita varten
Linkage rods for tandem axles
Timonerie de frein pour tandem
Tiranteria freno per tandem

	Jarrutankosarjain M 10 / Linkage rods for tandem axles M 10 <i>Timonerie de frein pour tandem M 10 / tiranteria freno per tandem M 10</i>		
	Pituus b Length b <i>Longueur b</i> Lunghezza b	Jarrutankosarjain, täydellinen Pull rod assembly, complete <i>Kit barre de traction cpl.</i> Kit barra di trazione completo	Vetotanko Pull rod <i>Barre de traction</i> Barra di trazione
	500 mm	05.439.34.40.0	03.399.25.46.0
	1100 mm	05.439.34.38.0	03.399.08.81.0
	1300 mm	05.439.20.52.0	03.399.25.01.0
	1400 mm	05.439.34.37.0	03.399.08.82.0
	1500 mm	05.439.20.54.0	03.399.25.02.0
	1700 mm	05.439.20.56.0	03.399.08.89.0
	2200 mm	05.439.20.62.0	03.399.25.05.0
	2700 mm	05.439.20.67.0	03.399.25.07.0
	300 mm		03.399.08.98.0
	1000 mm		03.399.08.99.0

Vetotankosarjain / Pull rod assembly kit / *Kit barre de traction cpl.* / Conjunto barra de tracción:
05.439.24.98.0

sisältäen: Tasapainotusvipu (3x) Rengas (9x) 6-kulmamutteri (11x) Vetotanko (1000 mm) Vetotanko (300 mm)
comprising: Equalizing lever (3x) Ring (9x) Hexagon nut (11x) Pull rod (1000 mm) Pull rod (300 mm)
se composant de : Levier compensateur (3x) Anneau (9x) Ecrou à tête hexagonale (11x) Barre de traction (1000 mm) Barre de traction (300 mm)
costituita da: Leva compensatrice (3x) Anello (9x) Dado esagonale (11x) Barra di trazione (1000 mm) Barra di trazione (300 mm)

	Jarrutankosarjain M 12 / Linkage rods for tandem axles M 12 <i>Timonerie de frein pour tandem M 12 / tiranteria freno per tandem M 12</i>		
	Pituus Length <i>Longueur</i> Lunghezza	Jarrutankosarjain, täydellinen Pull rod assembly, complete <i>Kit barre de traction cpl.</i> Kit barra di trazione completo	Vetotanko Pull rod <i>Barre de traction</i> Barra di trazione
	140 mm / 840 mm	05.439.32.91.0	03.399.02.76.0 03.399.02.08.0
	150 mm		03.399.05.90.0

	Jarrutankosarjain M 12 / Linkage rods for tandem axles M 12 <i>Timonerie de frein pour tandem M 12 / tiranteria freno per tandem M 12</i>		
	Pituus Length <i>Longueur</i> Lunghezza	Jarrutankosarjain, täydellinen Pull rod assembly, complete <i>Kit barre de traction cpl.</i> Kit barra di trazione completo	Vetotanko Pull rod <i>Barre de traction</i> Barra di trazione
	100 mm / 800 mm	05.439.19.26.0	03.399.05.03.0
	150 mm		03.399.05.90.0

4.1 Jarrutangot pariakseleita varten Linkage rods for tandem axles *Timonerie de frein pour tandem* Tiranteria freno per tandem

Kaksoistasapainotusjärjestelmä jarrutankoja varten M 10
Tandem compensation for brake linkage M 10
Palonnier de tandem pour timonerie de frein M 10
Compensazione per tandem per tiranteria freni M 10

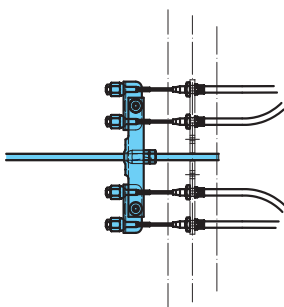

05.803.18.36.0:

sisältäen: Kaksoistasapainotustanko (1x), 6-kulmamutteri (1x), 6-kulmamutteri M 10 (2x), kuulamutteri M 8 (4x), 6-kulmamutteri M 8 (4x)

comprising: tandem compensation (1x), hexagon nut (1x), hexagon nut (M 10, 2x), spherical nut (M 8, 4x), hexagon nut (M 8, 4x)

se composant de : *palonnier de tandem (1x), écrou à tête hexagonale (1x), écrou à tête hexagonale (M 10, 2x), écrou sphérique (M 8, 4x)*

costituita da: compensazione per tandem (1x), dado esagonale (1x), dado esagonale (M 10, 2x), dado a sede sferica (M 8, 4x), dado esagonale (M 8, 4x)

Kaksoistasapainotusjärjestelmä jarrutankoja varten M 12
Tandem compensation for brake linkage M 12
Palonnier de tandem pour timonerie de frein M 12
Compensazione per tandem per tiranteria freni M 12

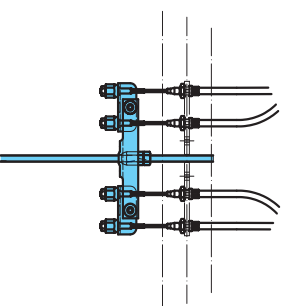

05.803.18.37.0:

sisältäen: Kaksoistasapainotustanko (1x), 6-kulmamutteri (1x), 6-kulmamutteri M 12 (2x), kuulamutteri M 8 (4x), 6-kulmamutteri M 8 (4x), Kugelscheibe (1x)

comprising: tandem compensation (1x), hexagon nut (1x), hexagon nut (M 12, 2x), spherical nut (M 8, 4x), hexagon nut (M 8, 4x), spherical washer (1x)

se composant de : *palonnier de tandem (1x), écrou à tête hexagonale (1x), écrou à tête hexagonale (M 12, 2x), écrou sphérique (M 8, 4x), rondelle à portée sphérique (1x)*

costituita da: compensazione per tandem (1x), dado esagonale (1x), dado esagonale (M 12, 2x), dado a sede sferica (M 8, 4x), rondella a sede sferica (1x), dado esagonale (M 8, 4x)

4.2 Iskunvaimentimet Shock absorber *Amortisseur* Ammortizzatore

Iskunvaimentimet SWING- kumijousituksella varustettuja akseleita varten Shock absorber for SWING rubber suspension axles <i>Amortisseurs pour essieux à suspension caoutchouc SWING</i> Ammortizzatore con barra in gomma SWING						
Kuormitusalue / Akselipaino Weight ranges / axle load <i>Plages de poids/ charge sur essieu</i> Livelli di carico / carico sull'asse	Tuntomerkit Designation <i>Indication</i> Dati targhetta	BPW -osano. BPW code no. <i>Réf. BPW</i> N.°di rif. BPW	Mitat Dimensions <i>Dimensions</i> Dimensioni	Asennusmitoitus noin Installation dimensions approx. <i>Encombrement env.</i> Ingombro di montaggio ca.		
550 kg - 1050 kg	punainen / red / <i>rouge</i> / rosso	02.3722.68.00	Lmin= 237 mm	Lmax= 337 mm	245 mm	
1050 kg - 1350 kg	sininen / blue / <i>bleu</i> / blu	02.3722.66.00	Lmin= 237 mm	Lmax= 337 mm	245 mm	
1350 kg - 1800 kg	musta / black / <i>noir</i> / nero	02.3722.39.00	Lmin= 237 mm	Lmax= 337 mm	245 mm	
1800 kg - 3000 kg	musta / black / <i>noir</i> / nero	05.323.60.04.0	Lmin= 270 mm	Lmax= 412 mm	280 mm	
Iskunvaimentimet RONDO -vääntösauvajousituksella varustettuja akseleita varten Shock absorber for RONDO torsion bar axles <i>Amortisseurs pour essieux à barre de torsion RONDO</i> Kit ammortizzatore con barra di torsione RONDO						
Kuormitusalue / Akselipaino Weight ranges / axle load <i>Plages de poids/ charge sur essieu</i> Livelli di carico / carico sull'asse	Tuntomerkit Designation <i>Indication</i> Dati targhetta	BPW -osano. BPW code no. <i>Réf. BPW</i> N.°di rif. BPW	Mitat Dimensions <i>Dimensions</i> Dimensioni	Asennusmitoitus noin Installation dimensions approx. <i>Encombrement env.</i> Ingombro di montaggio ca.		
1350 kg - 1800 kg	musta / black / <i>noir</i> / nero	02.3722.39.00	Lmin= 237 mm	Lmax= 337 mm	245 mm	
1800 kg - 3000 kg	musta / black / <i>noir</i> / nero	05.323.60.04.0	Lmin= 270 mm	Lmax= 412 mm	280 mm	
Yleismalliset iskunvaimentimet Universal shock absorber <i>Amortisseur universel</i> Ammortizzatore universale						
Kuormitusalue / Akselipaino Weight ranges / axle load <i>Plages de poids/ charge sur essieu</i> Livelli di carico / carico sull'asse	Tuntomerkit Designation <i>Indication</i> Dati targhetta	BPW -osano. BPW code no. <i>Réf. BPW</i> N.°di rif. BPW	Mitat Dimensions <i>Dimensions</i> Dimensioni	Asennusmitoitus noin Installation dimensions approx. <i>Encombrement env.</i> Ingombro di montaggio ca.		
550 kg - 1500 kg	musta / black / <i>noir</i> / nero	02.3702.27.00	Lmin= 257 mm	Lmax= 385 mm	270 mm	

Erilliset iskunvaimentimet pariakseleita CB 2/1050 ja BPW -alustaa varten Loose shock absorber for tandem axles CB 2/1050 and BPW Chassis <i>Amortisseur séparé pour tandem CB 2/1050 et châssis BPW</i> Ammortizzatore sciolto per tandem CB 2/1050 e carrelli BPW			
BPW -osano. BPW code no. <i>Réf. BPW</i> N.°di rif. BPW	Mitat Dimensions <i>Dimensions</i> Dimensioni	Asennusmitoitus noin Installation dimensions approx. <i>Encombrement env.</i> Ingombro di montaggio ca.	
02.3702.53.00	Lmin= 218 mm Lmax= 325 mm	225 mm	

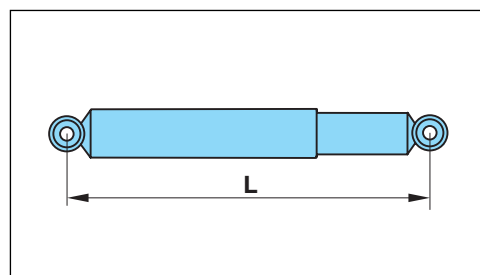

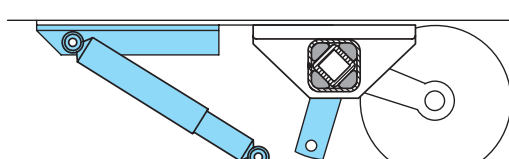
Iskunvaimentimien asennussarja (2 kpl) max. 1500 kg akseleita varten Shock absorber assembly kit (2 pieces) for axles up to 1500 kg <i>Kit de montage pour amortisseurs (2 pièces) pour essieux jusqu'à 1500 kg</i> Kit montaggio ammortizzatore (2 pezzi) per assale fino a 1.500 Kg	
	BPW -osano. BPW code no. <i>Réf. BPW</i> N.°di rif. BPW
	05.323.01.29.0